

11. Grigor'ev D. S. Nekotorye kineticheskie zakonomernosti uglerodotermicheskogo vosstanovleniya smesi okaliny bystrorezhushchey stali s dobavkami sheelitovogo kontsentrata // Metall i lit'e Ukrainy. 2010. Issue 9-10. P. 57–61.
12. Tsvirko E. I., Grigor'ev D. S. Nekotorye fazovye i strukturnye prevrashcheniya pri uglerodotermicheskom vosstanovlenii smesi okaliny bystrorezhushchih staley s dobavkami sheelitovogo kontsentrata // Novi materialy i tekhnologii v metalurhii ta mashynobuduvanni. 2010. Issue 2. P. 90–94.
13. Grigor'ev D. S. Nekotorye fazovye i veshchestvennye prevrashcheniya pri uglerodotermicheskom vosstanovdenii sheelitovogo kontsentrata // Stal'. 2011. Issue 11. P. 60–63.
14. Grigor'ev D. S. Sovershenstvovanie metoda opredeleniya stepeni vosstanovleniya vol'framovogo kontsentrata // Novi materialy i tekhnolohiyi v metalurhii ta mashynobuduvanni. 2010. Issue 2. P. 72–75.

Розроблена автоматизована система вимірювань для визначення крайових кутів змочування та розрахунку компонентів вільної поверхневої енергії (ВПЕ) твердих поверхонь методом Ван Осса-Чодері-Гуда. Визначені крайові кути змочування і значення складових ВПЕ наповнених епоксидних полімерних композитів, сталі і скла. Показано, що вміст рутилу (TiO_2) впливає на структуру і властивості епоксидних композитів і це найбільш яскраво відображається зміною кислотної та основної компонентів ВПЕ. Встановлено, що структурні перетворення пов'язані з кислотно-основним механізмом міжмолекулярних і між фазних взаємодій

Ключові слова: вільна поверхнева енергія, автоматизована система вимірювань, епоксидний композит, рутил

Разработана автоматизированная система измерений для определения краевых углов смачивания и расчета компонентов свободной поверхностной энергии (СПЭ) твердых поверхностей методом Ван Осса-Чодери-Гуда. Определены краевые углы смачивания и значения составляющих СПЭ наполненных эпоксидных полимерных композитов, стали и стекла. Показано, что содержание рутила (TiO_2) влияет на структуру и свойства эпоксидных композитов и это наиболее ярко отражается изменением кислотно и основной компонентов СПЭ. Установлено, что структурные преобразования связаны с кислотно-основным механизмом межмолекулярных и межфазных взаимодействий

Ключевые слова: свободная поверхностная энергия, автоматизированная система измерений, эпоксидный композит, рутил, структура

UDC 691.175.2

DOI: 10.15587/1729-4061.2018.120998

STUDY OF THE FREE SURFACE ENERGY OF EPOXY COMPOSITES USING AN AUTOMATED MEASUREMENT SYSTEM

Yu. Danchenko

PhD, Associate Professor

Department of General Chemistry*

E-mail: u_danchenko@ukr.net

V. Andronov

Doctor of Technical Sciences, Professor

Research Center**

M. Teslenko

Postgraduate student

Department of automation of manufacturing processes*

V. Permiakov

PhD, Professor

Department of automation of manufacturing processes*

E. Rybka

PhD

Research Center**

R. Meleshchenko

PhD

Department of fire and rescue training**

A. Kosse

PhD, Associate Professor

Department of Fire Prevention in Settlements**

*Kharkiv National University of

Civil Engineering and Architecture

Sumska str., 40, Kharkiv, Ukraine, 61002

**National University of Civil Protection of Ukraine

Chernyshevska str., 94, Kharkiv, Ukraine, 61023

1. Introduction

Free surface energy (FSE), which characterizes energy state of a solid surface, can be a criterion for the evaluation of protective and operational properties of polymeric com-

posite materials. In some cases, FSE is an essential characteristic for studying the properties of polymeric coatings and films, adhesive contacts and adsorption of polymers. There are many studies focusing on determining FSE using different methods and correlating the properties of different

materials, including epoxy polymeric composite materials. As a result of comparing FSE of the polymers obtained by different methods, it can be argued that in general these values are close. This suggests a possibility for using FSE of polymers for practical purposes with a sufficient degree of reliability. Exploring FSE and establishing interconnections between FSE, the structure and properties of polymeric materials, is a relevant task. This would help resolve the tasks on the control over properties, as well as on the creation of epoxy polymeric composite materials with predefined characteristics.

2. Literature review and problem statement

Correlation of the magnitudes of FSE to the properties of polymeric materials is predetermined by a direct association with intramolecular interactions and cohesion energy [1, 2]. Thus, for many non-filled polymers, a linear correlation between destructive stress at tension and the dispersed component of FSE was observed. Authors of [3–6] conducted experimental research into energy surface characteristics of a wide range of different polymeric composite materials. It was found that determining FSE components makes it possible to predict and purposefully regulate adhesion interactions between surfaces of various materials. It was shown in paper [3] that the criterion for selecting modifying surface-active additives for the regulation of adhesive strength in the system “epoxy polymer – steel” can be the polar FSE component. The results obtained indicate a close relationship between internal interactions of functional (polar) groups of polymer’s molecules and modifying additives and surface energy characteristics of solid composite materials.

In contrast to the non-filled polymers, FSE of materials with fillers was not sufficiently explored. It is known that during filling the low energy intramolecular bonds, which can affect energy state of the surface of a composite, are formed between functional groups of polymers’ molecules and the surface of a filler [5–8]. The influence of the nature of surface, particles’ dimensions, and the content of a filler on the magnitude of FSE of composite materials was noted in studies [4, 9, 10]. Theoretical and experimental substantiation of the connection between FSE and inter-phase interactions in the filled polymeric materials was considered in [8]. In paper [9], mathematical modeling of influence of the content and energy surface characteristics of a filler on FSE of epoxy materials was performed. The model was built based on the concept of adhesive acidic-basic inter-phase interaction between the epoxy polymeric matrix and the surface of the filler. The possibility for predicting FSE components of the epoxy filled polymers was shown. In paper [11], interactions between fillers with different surface acidic-basic properties and butadiene rubber were explored. It was shown that composites with fillers whose surface is characterized by a highly dispersed FSE component are more durable.

However, the findings reported in the scientific literature do not allow for drawing the generalized conclusions about a degree of influence of fillers on the magnitude of FSE of polymeric composites. In addition, the relationship between components of FSE and the structure and properties of composites was not established. That is why further research, prediction and regulation of FSE of polymeric composites that contain fillers, is an important scientific

and practical task. Establishing these regularities will make it possible to obtain composite materials with predefined properties and characteristics.

Modern methods for determining and calculation of FSE are based on the equations by Dupree, Young, and the Berthelot hypothesis [12–14]. At present, indirect methods for estimating FSE of solid materials are commonly used, based on experimental measurement of contact wetting angles of surfaces with test substances with known values of surface tension. To determine FSE of polymers, the methods by Fouks, Owens-Wendt, and Van Oss-Chaudhury-Good (VOCG) are used most frequently [12–16]. The first two methods allow determining total FSE and dispersive (Liphshitz – Van der Waals) and polar (acidic-basic) components. To do this, two test fluids with different polarities are applied [16–18]. When applying the VOGC method and using three test fluids with different acidity functions, it becomes possible to calculate acidic (electron-acceptor) and basic (electron-donor) components of the polar constituent of FSE [4, 10].

When determining FSE experimentally, the crucial point is correct measurement of contact angles of wetting a surface with test liquids. Under ordinary conditions, the process of measuring is influenced by several external factors. They include temperature, chemical purity of testing liquids, drop applying technique, accuracy of measurement of geometrical parameters of drops. Hysteresis of contact angles and duration of establishing equilibrium wetting depend on horizontality, roughness and the absence of outside substances at the surface.

To minimize impact factors, automated measurement systems that employ computer technology are applied in practice [14, 16, 19–21]. Digital cameras with high resolution and low minimum distance from an object, or microscopes that may connect to a computer, are used for measurements. The acquired images of drops are processed in the automated mode. In this case, existing computer programs allow for determining the values of contact wetting angles, but they are not designed to calculate FSE components. That is why, in order to reduce time for conducting experiments, and to eliminate a possibility of the emergence of random errors, it is expedient to expand computational capabilities of existing computer software. Thus, in addition to the automated measurement of contact wetting angles, it is necessary to automate computation of total, dispersive, polar, acidic, and basic FSE components.

Thus, in the course of an analysis it was found that in order to regulate and predict properties of the filled epoxy polymeric materials, it is required to undertake further studies into surface energy characteristics, specifically FSE components. Information about the patterns of change in FSE components of composites will make it possible to understand the mechanisms of inter-phase interactions with participation of functional groups of polymers’ molecules and the surface of fillers. In this case, the unresolved problem is the role of each of the components (dispersive, polar, acidic, and basic) in the formation of structure and properties of composites. To obtain reliable results, it is necessary to ensure correct measurement of the values of contact wetting angles of the surface of epoxy materials with test liquids, which could be used in subsequent calculations. It is obvious that the creation of maximally automated systems for measuring and calculations will make it possible to obtain more accurate and reliable results.

3. The aim and objectives of the study

The aim of present study is to examine surface energy characteristics of the filled epoxy composite materials using an automated measurement system. This will make it possible to obtain maximally reliable results of measurements and calculations, which are used to regulate and predict properties of composites.

To accomplish the set goal, the following tasks are formulated:

- to establish a possibility of applying an automated measurement system for determining contact wetting angles and calculating FSE components;
- to explore the relationship between FSE components, the structure and properties of the filled epoxy composites.

4. Materials and methods of research

Filled polymer compositions based on epoxy resin of brand ED-20 (DSTU 2093-92) and stoichiometric amount of aliphatic amine solidifier diethylenetriamine of DETA brand (TU 6-02-91486) were used as materials for the study. Solidification mode and technological sequence of compositions preparations were described in [22]. The filler was air-dry dispersed inorganic material rutile with dimensions of particles of ~10 μm. Rutile was added to compositions in the amount of 1; 2.5; 5; 10 % by volume. Specific surface of the filler $S_{sp}=1.3 \text{ m}^2/\text{g}$ was determined by the BET method (Brunauer, Emmett, Teller). X-ray phase analysis was performed on the X-ray diffractometer DRON-2 (Russia). The function of acidity of active centers that prevail on the surface of rutile was determined by the method of potentiometric measurement of pH_{susp} in water, which is described in [23]. To determine pK_a spectrum of active centers on the surface of rutile, the Hummett method of adsorption of colored indicators from aqueous solutions was used [24]. In this case, the number of acidic q_{acid} , basic q_{base} and the sum of active centers q_{sum} were determined. Acidic-basic indicator $Q=q_{\text{acid}}/q_{\text{base}}$ was also calculated. The studied properties of rutile are given in Table 1 and shown in Fig. 1.

Properties of rutile

Filler	pK_a	$q_{\text{acid}} \cdot 10^{-12}, 1/\text{cm}^2$	$q_{\text{base}} \cdot 10^{-12}, 1/\text{cm}^2$	$q_{\text{sum}} \cdot 10^{-12}, 1/\text{cm}^2$	Q	Mineral composition
Rutile GOST 22938-78 (RT)	8.2–8.5	72.9	95.8	168.7	0.76	Rutile (TiO_2) Anatase (TiO_2)

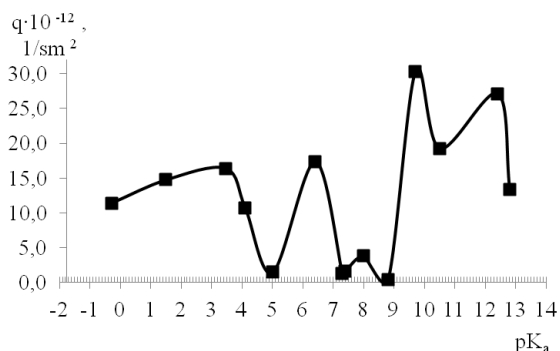

Fig. 1. pK_a spectrum of active centers on the surface of rutile

For the received samples of filled composites, thermogravimetric (TG) method and the method of differential scanning calorimetry (DSC) with the use of SDT Q600 device, produced by TA Instruments company (USA) were used. The studies were conducted in argon atmosphere in the temperature range of 20–900 °C at the temperature increase rate of 5 °C/min. The weight of the sample was 1.5–4 mg. Temperature intervals of destruction stages were evaluated by the temperature curve of mass loss. Temperature of glass transition was determined by DSC curve. Chemical resistance of composites to water and aqueous solutions was studied by the method of immersion of samples in aggressive aqueous media. The tests were carried out at a temperature of $20 \pm 5 \text{ }^\circ\text{C}$, with subsequent calculation of the relative increase in the mass of the sample over a period of time (GOST 4650-80, GOST 12020-72). Distilled water and 0.1 n solutions of NaOH and H_2SO_4 were used as aggressive media. Dependences of an increase in mass $\Delta m=(m_0-m) \cdot 100/m_0$ on the time of keeping τ of samples in aggressive media were studied.

Contact angles of wetting surfaces were determined by the method of a lying drop of test fluids at temperature of $20 \pm 5 \text{ }^\circ\text{C}$. Selected temperature is associated with the highest accuracy of measurement of contact wetting angles [25]. Distilled water, formamide and α -bromonaphthalene were used as test fluids. Energy characteristics of test fluids are given in Table 2.

Table 2

Components of surface energy (tension) of test fluids (mJ/m^2)

Test fluid	γ_l	γ_l^d	γ_l^p	γ_l^a	γ_l^b
Distilled water (DV)	72,8	21,8	51,0	25,5	25,5
Formamide (FA)	58,0	39,0	19,0	2,3	39,6
α -bromonaphthalene (BN)	44,6	44,6	0,0	0,0	0,0

To determine mean value of contact angles, parallel measurement of geometrical parameters of 10–15 drops were performed. The drops of test fluids were applied on previously degreased surface (in sequence by gasoline and acetone).

Table 1

Equilibrium values of contact angles for water were determined after 10, for formamide after 120 and for α -bromonaphthalene after 30 seconds after application. Epoxy coatings of thickness of 1–1.5 mm steel plates were used as polymer surfaces. Calculation of contact wetting angles, FSE and of components was performed with the help of the automated measurement system (AMS). To determine reliability of the results, obtained using AMS, the surfaces of steel and glass were studied.

5. Results of determining contact wetting angles and components of free surface energy

The purpose of development of AMS is to determine contact wetting angles and calculate components of FSE of solid surfaces, including polymer surfaces, with the use of the VOCC method. Calculation was based on experimental measurement of geometrical parameters of a lying drop on the surface and energy characteristics of test fluids.

Contact wetting angles were calculated as angles of slope of the tangent to the line of contact fluid – solid at the point of three-phase contact between the solid surface, air and a drop of test liquid [12, 16]. Automation of the method lies in the use of software for measurement. A digital image of a drop on the surface was used as an output signal. To carry out measurements, we created a laboratory set-up, the schematic of which is shown in Fig. 2.

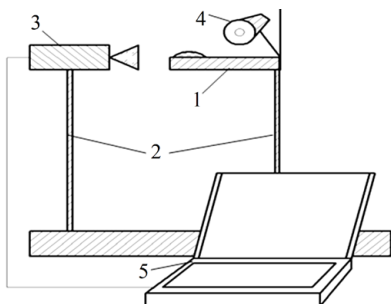
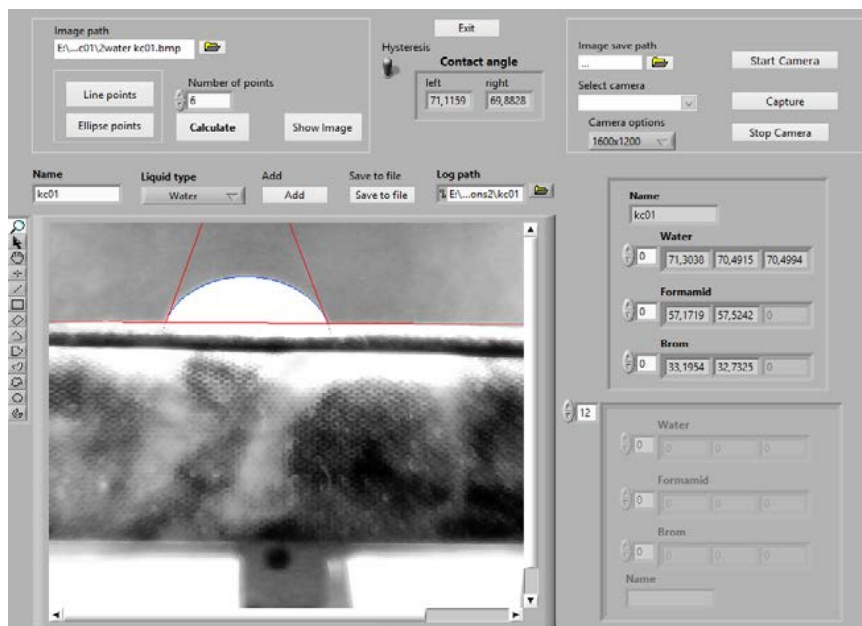

Fig. 2. Schematic of laboratory set-up: 1 – stand for exploring surfaces; 2 – tripods with possibility of adjustment; 3 – digital camera; 4 – source of scattered light; 5 – personal computer

The algorithm for determining wetting angles was developed based on the mathematical model of the drop's projection onto the surface. The model describes the drop's projection in the form of an ellipse, which is intersected by a straight line. The ellipse was determined in polar coordinates, after that, there was a transition to Cartesian coordinate system. As a result, a set of points that describe the outline of a drop was obtained. The location of a drop in the coordinates of a digital image can be conditionally arbitrary, that is, have a certain shift and a slope. Parameters were added to the basic model and the formula for obtaining the derivative was modified taking this into account. Thus, the constructed model allowed for describing the drop's projection on the surface with any assigned contact angle. Determining a wetting angle by the actual image involved restoration of parameters of the original model by limited data. Discrete coordinates on the drop's contours were used as these data. Approximation for restoration of parameters of the ellipse and the straight line, describing the drop's contours relative to the model, was performed. The equation of second order curve was used for approximation of the line of the fluid–gas contact. It made it possible to determine the ellipse, located arbitrarily in coordinates of the image.

Based on the proposed algorithm, the software “Least Square Wetting Analyzer” in the LabVIEW graphic programming environment was developed. The data, obtained during the experiment, were recorded in a binary file, and used for subsequent calculations. A separate program was developed in order to carry out automated calculations of FSE. A possibility to read a binary file with values of contact angles was implemented. Calculation of total FSE and the components using the VOCC method was performed in the program. For this purpose, the system of equations was solved [13]. The interfaces of the software are shown in Fig. 3.



a

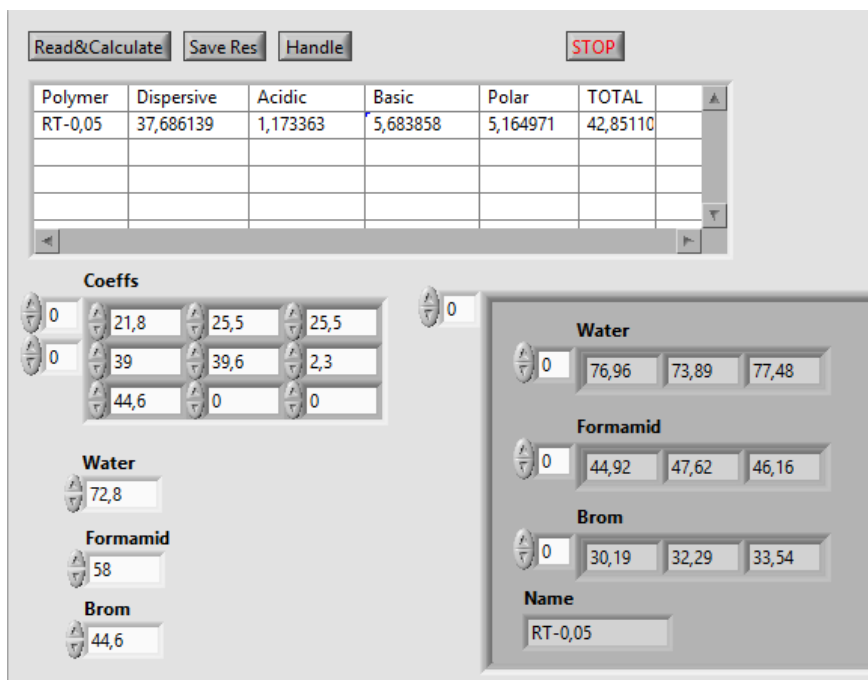

b

Fig. 3. Interfaces of software to calculate: a – contact wetting angles; b – FSE components

To improve accuracy, it was planned to carry out a series of measurements and to use the mean value of a contact angle for subsequent calculations of free surface energy. The mean value considered hysteresis of wetting. Obtained values of contact wetting angles and FSE components were recorded in the table and stored in files. The program implies the possibility of adjustment for different types of fluids.

With the help of AMS, contact wetting angles with test liquids of the selected surfaces were determined. Specifically, they included steel, glass, epoxy composite (EP) and composites with 1 (EP+RT1), 2.5 (EP+RT2.5), 5 (EP+RT5) and 10 % by volume (EP+RT10) of rutile. To assess reliability of the results, confidence interval was calculated. Results of measurements and calculations are given in Table 3.

Table 3
Magnitudes of contact wetting angles of surfaces with test fluids

Surface	Contact wetting angle of surfaces θ with test fluids, degree		
	DW	FA	BN
EP	78.4±1.6	63.1±2.3	41.1±2.6
EP+RT1	70.7±3.0	51.9±2.7	30.2±1.2
EP+RT2.5	65.9±2.5	48.2±2.8	32.7±3.0
EP+RT5	74.4±2.1	47.0±1.9	33.0±2.5
EP+RT10	70.6±3.0	50.9±1.2	37.5±2.2
Steel	83.9±1.8	77.8±1.4	36.4±1.7
Glass	39.9±2.1	24.4±1.3	39.9±0.8

As we can see from data in Table 3, confidence interval of the measured contact wetting angles with a probability of 0.95 does not exceed ±3.0 degrees.

FSE components for the studied surfaces were calculated according to obtained values of contact wetting angles. The following values were calculated: γ_s of total FSE; γ^d of dispersive component; γ^{ab} of acidic-basic or polar component, which is divided into γ^a – acidic and γ^b – basic components. Results of calculations were compared to measurements, made by the national and foreign authors. Calculation results are given in Table 4 and shown in Fig. 4.

Table 4
FSE components for non-filled epoxy composites, steel and glass (mJ/m²)

Surface	γ^d	γ^{ab}	γ^a	γ^b	γ_s
ED-20+DETA (EP)	34.3	0.8	0.02	9.7	35.0
ED-20+DETA [4]	32.4	6.0	7.5	1.2	39.1
ED-20+DETA [5]	36.1	6.8	–	–	42.9
Steel	35.9	13.0	2.7	16.6	49.3
Steel [26]	35–49	19–26	–	–	61–69
Steel [4]	32.5	0	8.8	0	32.5
Steel [5]	22–26	8–19	–	–	34–39
Glass	34.8	18.0	2.5	32.5	52.8
Glass [14]	32.7	17.6	1.7	45.3	50.1

When comparing magnitudes of FSE components of the non-filled epoxy composites ED-20+DETA, satisfactory

correlation with known data of magnitudes of total FSE and dispersive component was revealed (Table 4). A significant difference in values of the polar and, respectively, acidic and basic components can be attributed to the difference in solidifying modes of the compositions. Thus, in [4, 5], solidification of composites was performed in the air under normal conditions (20–25 °C). For the studied compositions, in addition to solidification in the air, heat treatment was conducted at $T=100$ °C for 4 hours. In this case, an additional number of polar functional groups of oligomers and solidifiers are obviously involved in solidification process and polar FSE component may decrease. This conclusion is confirmed in the research from paper [27], where it is shown that an increase in temperature of solidification of epoxy compositions corresponds to a decrease in FSE and components.

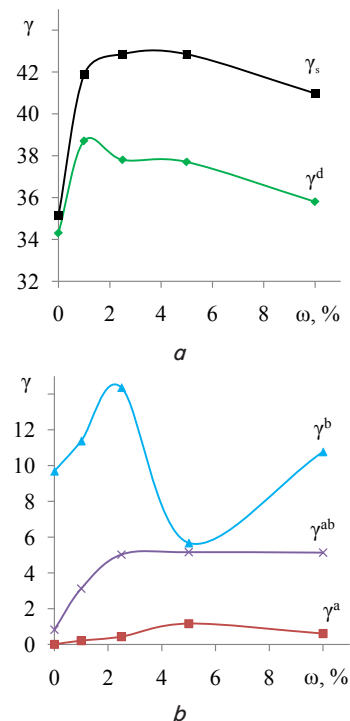

Fig. 4. Dependences of FSE components (mJ/m²) of epoxy composites on rutile content: *a* – total γ_s and dispersive γ^d ; *b* – acidic-basic γ^{ab} , acidic γ^a and basic γ^b

It is necessary to note a satisfactory correlation of obtained FSE values and the known data for glass [14]. Minor deviations are explained by the use of different sets of test fluids. Thus, distilled water, formamide and diiodomethane were used in research [14].

The most contradictory results were obtained for FSE of steel (Table 4). When comparing the known and the obtained results, it was found that magnitudes of FSE of steel vary in a wide range. This is due to the fact that FSE of steel samples significantly depends on a chemical composition of an alloy and presence of oxidation products (oxide films) on the surface [4]. At the same time, roughness degree of steel plates was found to have virtually no impact on the value of FSE components [26]. However, obtained values of FSE components of steel samples are within the limits, defined by other authors. Thus, we can conclude that the performed comparative analysis to data from studies [4, 5, 14, 26] indicate the adequacy of the results obtained.

6. Results of research into structure and properties of epoxy compositions filled with rutile

It is known that resistance of the netted polymer structure is directly proportional to the resistance of epoxy polymeric composites to the effect of high temperatures [28, 29]. That is why thermal methods of thermogravimetry (TG) and differential scanning calorimetry (DSC) were used for studying the structural features of the filled composites. In this case, mass loss of samples depending on temperature and composites' glass transition temperature T_c were determined. Results of the thermal tests of composite (EP) and composites, filled with rutile, are given in Table 5 and shown in Fig. 5.

Table 5

Results of thermal analysis of epoxy composites

Composites	T_c , °C at mass loss, %				Coke residue, %
	5	10	50	90	
EP	295	325	330	330	2,0
EP+RT1	220	250	400	515	10,0
EP+RT2.5	248	305	405	545	0
EP+RT5	260	285	360	360	2.5
EP+RT10	250	308	400	400	0

Results of determining chemical resistance of epoxy composites in aggressive aqueous solutions are shown in Fig. 5, *b*.

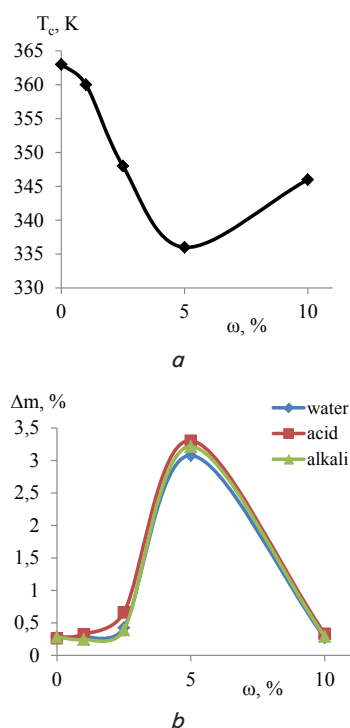

Fig. 5. Dependences on rutile content ω : *a* – of composites' glass transition temperature (T_c), *b* – of mass increase Δm of composites' samples in aqueous solutions

The obtained results of experimental research make it possible to form the understanding of the impact of rutile content on the structure and properties of epoxy composites.

7. Discussion of results of research into correlations between FSE components and structure of epoxy composites

From dependencies, shown in Fig. 5, it is clear that the addition of rutile significantly affects both total FSE of composite and separate components. These results correlate with the studies of other authors [5, 7]. Thus, the influence of fillers on FSE components of polymer materials, filled with oxides TiO_2 and Cr_2O_3 [5] and inorganic polysiloxane particles [7], was noted. The authors showed that the addition of fillers has ambiguous impact on the value and change in FSE components. The reasons for this are not analyzed by the authors. The results obtained are isolated and fragmentary and do not allow for understanding the character of a change in FSE composites depending on the nature and content of fillers.

As a result of research using AMS, it was found that at an increase in rutile content in EP composites, total FSE (γ_s), dispersive (γ^d) and acidic-basic (γ^{ab}) components increase (Fig. 5). Dependences γ_s and γ^d on the content of a filler are of the extreme character and γ^{ab} increases and at a subsequent increase of rutile amount does not change. The influence of rutile is represented most vividly by dependences of the acidic (γ^a) and basic (γ^b) components, into which acidic-basic FSE component γ^{ab} is disintegrated. Dependence γ^a increases monotonously, reaches maximum at rutile content of 5 % by volume and subsequently does not change essentially. Dependence γ^b has two extremums: maximum at rutile content of 2.5 % by volume and minimum at 5 % by volume. It should be noted that the impact of rutile on FSE of epoxy composites cannot be connected with conformational changes in the structure of the polymer. This fact was established by research [22], where it is shown that presence of TiO_2 oxide in the composition does not affect the conformation of a fragment of the net of epoxy amine polymer. Obtained results are obviously related to the fact that inorganic fillers tend to have high values of acidic and basic FSE components and can reach 500–700 mJ/m² [14, 30]. Thus, in paper [9], the possibility to regulate FSE components of filled epoxy composites, based on FSE of inorganic fillers and non-filled polymer, was shown. Thus, it was found that the acidic and the basic components of FSE can be the criteria that characterize the impact of rutile on the structure and properties of epoxy composites.

It can be assumed that a change in FSE of composites is obviously related to the intense acidic-basic interaction on the surface of phases' separation. Reactions occur between the surface-active centers (OH-groups) of rutile and functional groups of binding (OH-groups, oxygen of ordinary ether $-\text{C}-\text{O}-\text{C}-$ and epoxy groups, secondary or tertiary nitrogen of aminogroups, π -bond of benzene rings, etc.). Functionals are characterized by a certain acidic-basic function by Lewis or Bronsted [31, 32]. In this case, in polymeric composite materials without solvents, acidic-basic interactions between Bronsted functionals may not end in transition of a proton from an acid to a base, but rather interact by the Lewis principle.

In turn, the spectrum of active centers of Bronsted and Lewis on the surface of rutile is caused by a hydroxyl–hydrate layer, which is formed as a result of chemical and physical adsorption of water molecules. Using the potentiometric method and the method of adsorption of Hammett color in-

dicators, it was found that the surface of rutile has a general weakly basic character (Table 1). In this case, in addition to basic ($pK_a \approx 10-13$) centers, acidic centers both of Bronsted ($pK_a \approx 1.5-4$) and of Lewis ($pK_a \approx -0.29$) character are present on the surface (Fig. 1). The presence of rutile's surface centers by Lewis and Bronsted causes intense acidic-basic inter-phase interaction in the filled epoxy composite.

At adding small quantities of rutile 1–2.5 % by volume, an increase in all FSE components of composites EP+RT1 and EP+RT2.5 is associated with formation of inter-phase and intermolecular interactions of acidic-basic character. Acidic surface-active centers ($pK_a \approx -0.29-4$) can “block” basic epoxy and amine groups and, as a result, in the structure of the composite, specific share of “physical net” increases and the number of chemical cross-links decreases. Obviously, in this case, weakened structures with the system of non-covalent intermolecular bonds between particles of the filler and sections of the netted polymer are formed (Fig. 6, *a*). This assumption is proved by a decrease in glass transition temperature (Fig. 5, *a*) and a decrease in temperature of thermal destruction of composites (Table 5). Similar effects of plasticization of filled epoxy composites are described in papers [33–35].

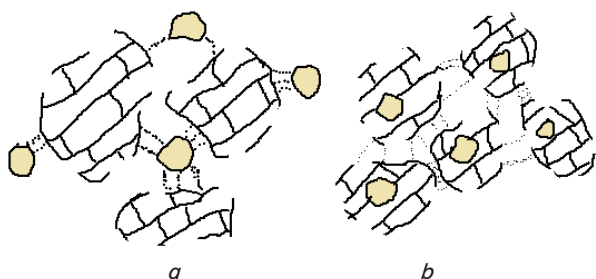

Fig. 6. Mechanism of structure formation in epoxy composites, filled with rutile: *a* – 1–2.5 % by volume of rutile; *b* – 5 % by volume of rutile

At a rutile content of 5 % by volume (EP+RT5), obviously, due to adsorption of molecules of epoxy oligomer on the surface of the filler, the reactions of polymerization and cross-linking primarily occur in the near-surface layer. Adsorption of molecules of oligomer happens on acidic ($pK_a \approx -0.29-4$) active centers of the surface of rutile. This is proved by research [36], which found that chemisorption bonds can be formed between surface OH-groups with $pK_a \approx 4$ of aluminum oxide and molecules of epoxy oligomers. Thus, the third phase of polymer, so-called adsorption “inter-phase layer” (IPL) is formed on the surface of the filler's particles. In this case, the structural organization of the composite changes considerably, and in it a system of non-covalent intermolecular bonds is formed between the structural elements from particles of the filler and thick IFL of the polymer on the surface (Fig. 6, *b*). Given that most IFL functionals interact with the surface of the filler, non-covalent bonds between structural elements are weak and low-energy. Absence of intermolecular bonds between the functional groups of the polymer and the fillers is represented by a sharp decrease in the basic FSE component (Fig. 4). Formation of a weaker structure is also proved by a decrease in T_c of the composite by 27 °C and temperature of thermal destruction by 35–50 °C and a sharp decrease in stability of composites in aqueous aggressive media. An increment in mass of the samples of composite in aqueous aggressive

media increases by 6–7 times (Fig. 5, *b*). Thus, we can speak about a kind of “a saturated state” of adsorption layers on the inter-phase surface. And concentration (content) of the filler (in this case, 5 % by volume) can be called “critical” (ω_{crit}), at which the weakest structure is formed and properties of composites worsen. Given acidic-basic mechanism of intermolecular interactions, it can be argued that ω_{crit} depends on acidic-basic characteristics of the surface of fillers, oligomers, solidifiers and other components in the compositions. To prove this assumption, it is needed to study additionally the composites, which include components with different ratio of acidic and basic functionals.

With an increase in the amount of rutile of up to 10 % by volume, FSE of highly filled composite EP+RT10 in comparison with the non-filled one, changes slightly (Fig. 4). Perhaps, in this case due to a small distance between particles of the filler and spatial difficulties, intensity of oligomer molecules adsorption decreases and polymer net is formed in the inter-particle space. In this case, possibility of acidic-basic inter-phase interactions is partially preserved. This is evidenced by an increase in γ_s and γ^b of the composite compared with non-filled one.

8. Conclusions

1. As a result of the conducted studies, the automated measurement system (AMS) for determining contact wetting angles and calculation of components of free surface energy (FSE) of solid surfaces by VACG method was developed. The created AMS allows for calculating based on experimental measurements of geometrical parameters of a lying drop on the surface and energy characteristics of test fluids. Using AMS, contact wetting angles were measured and values of FSE components of surfaces of epoxy polymer composites, steel and glass were calculated. Comparative analysis of the data reported by other authors indicates adequacy and reliability of results, obtained using AMS. Confidence interval of the measured contact wetting angles with a probability of 0.95 does not exceed ± 3.0 degrees.

2. Based on the conducted measurements and calculations, relationship between FSE, the structure and properties of epoxy polymer composites filled with rutile, was established. With the help of research, conducted with the use of AMS, it was found that at an increase of rutile content in composites EP, total FSE (γ_s), dispersive (γ^d) and acidic-basic (γ^{ab}) components increase. Dependences γ_s and γ^d on the filler's content are extreme in nature, and γ^{ab} increases and does not change at a subsequent increase in amount of rutile. The influence of rutile is represented most vividly by dependences of the acidic (γ^a) and basic (γ^b) components, into which acidic-basic FSE component γ^{ab} is disintegrated. When adding small quantities of rutile 1–2.5 % by volume, an increase in all FSE components of composites EP+RT1 and EP+RT 2.5 is associated with formation of inter-phase and intermolecular interactions of acidic-basic nature. Acidic surface-active centers ($pK_a \approx -0.29-4$) “block” basic epoxy and amine groups and specific share of “physical net” increases and the number of chemical cross-links in the structure of the composite decreases. In this case, weakened structures with the system of non-covalent intermolecular bonds between particles of the filler and sections of the netted polymer are formed. This is proved by a decrease in glass transition temperature and

a decrease in temperature of thermal destruction of composites. At rutile content of 5 % by volume (EP+RT5), an adsorption “inter-phase layer” is formed on the surface of the filler. In this case, there changes the structural organization of the composite, in which the system of intermolecular bonds is formed between the structural elements with particles of a filler and a thick inter-phase layer of polymer on the surface. The absence of intermolecular bonds between functional groups of the polymer and the fillers is expressed by a sharp decrease in the basic FSE component. Formation

of a weaker structure is also proved by a decrease in T_c of the composite by 27 °C and of temperature of thermal destruction by 35–50 °C and by a sharp decrease in resistance of composites in aqueous aggressive media. With an increase in the amount of rutile of up to 10 % by volume, FSE of composite EP+RT10, in comparison with the non-filled one, changes slightly. In this case, the possibility of acidic-basic inter-phase interactions is partially preserved. This is evidenced by an increase in γ_s and γ^b of the composite compared with the non-filled one.

References

1. Stamm M. Polymer surfaces and interfaces: characterization, modification and applications. Springer, 2008. 324 p. doi: 10.1007/978-3-540-73865-7
2. Surface science techniques. Vol. 51 / G. Bracco, B. Holst (Eds.) // Springer Series in Surface Sciences. 2013. doi: 10.1007/978-3-642-34243-1
3. Barabash E. S., Popov Yu. V., Danchenko Yu. M. Vliyanie modifitsiruyushchih dobavok na adgezionnyuyu sposobnost' epoksiaminnyh svyazuyushchih k alyumoborsilikatnomu steklu i stali // Naukovyi visnyk budivnytstva. 2015. Issue 4. P. 122–128.
4. Starostina I. A., Stoyanov O. V. Kislотно-osnovnyye vzaimodeystviya i adgeziya v metall-polimernykh sistemah. Kazan': Izd-vo Kazan. gos. Tekhnol. un-ta, 2010. 200 p.
5. Epoksipolimernye adgezionnye praimery v antikorrozionnoy izolyatsii truboprovodov / Stroganov V. F., Stroganov I. V., Ahmetshin A. S., Stoyanov O. V., Starostina I. A. // Izvestiya KGASU. 2010. Issue 1. P. 342–346.
6. Danchenko Yu. M., Popov Yu. V., Barabash O. S. Vplyv kyslотно-osnovnykh vlastyvostei poverkhni poli mineralnykh napovniuvachiv na strukturu ta kharakterystyky epoksykompozytiv // Voprosy himii i himicheskoy tekhnologii. 2016. Vol. 3 (107). P. 53–60.
7. Yashchenko L. N. Svoystva polisiloksansoderzhashchih epoksiuretanovykh nanokompozitov angidridnogo otverzheniya // Ukrainskiy himicheskyy zhurnal. 2017. Vol. 83, Issue 4. P. 73–80.
8. Surface interaction energy simulation of ceramic materials with epoxy resin / Li F.-Z., Lu Z.-L., Yang Z.-H., Qi K. // Polimery. 2015. Vol. 60, Issue 07/08. P. 468–471. doi: 10.14314/polimery.2015.468
9. Danchenko Yu. M. Regulation of free surface energy of epoxy polymer materials using mineral fillers // Polymer materials and technologies. 2017. Vol. 3, Issue 2. P. 56–63.
10. Zapata-Massot C., Le Bolay N. Effect of the Mineral Filler on the Surface Properties of Co-Ground Polymeric Composites // Particle & Particle Systems Characterization. 2007. Vol. 24, Issue 4-5. P. 339–344. doi: 10.1002/ppsc.200701136
11. Filler-elastomer interactions: surface and mechanical interfacial properties of chemical surface treated silica/rubber composites / Park S.-J., Kim J.-S., Rhee K.-Y., Min B.-G. // Mater. Phys. Mech. 2001. Issue 4. P. 81–84.
12. Zenkiewicz M. Methods for the calculation of surface free energy of solids // Journal of Achievements in Materials and Manufacturing Engineering. 2007. Vol. 24, Issue 1. P. 137–145.
13. Żenkiewicz M. Comparative study on the surface free energy of a solid calculated by different methods // Polymer Testing. 2007. Vol. 26, Issue 1. P. 14–19. doi: 10.1016/j.polymertesting.2006.08.005
14. Hejda F., Solar P., Kousal J. Surface free energy determination by contact angle measurements – a comparison of various approaches. P. III // WDS'10 Proceeding of Contributed Papers. 2010. P. 25–30.
15. Carré A. Polar interactions at liquid/polymer interfaces // Journal of Adhesion Science and Technology. 2007. Vol. 21, Issue 10. P. 961–981. doi: 10.1163/156856107781393875
16. Metody issledovaniya sovremennykh polimernykh materialov: ucheb. metod. pos. Nizhniy Novgorod: Nizhegorodskiy gosuniversitet, 2012. 90 p.
17. Vliyanie ammonievyykh soedineniy s kislород- i serosoderzhashchimi fragmentami na gidrofilizatsiyu epoksidnogo polimera / Foss L. E., Fahretdinov P. S., Romanov G. V., Bogdanova S. A. // Vestnik Kazanskogo tekhnol. universiteta. 2011. Issue 7. P. 132–136.
18. Aspects of polymer surfaces wetting / Sviderskiy V. A., Mironyuk A. V., Pridatko A. V., Sivolapov P. V. // Eastern-European Journal of Enterprise Technologies. 2014. Vol. 6, Issue 1 (64). P. 23–26. doi: 10.15587/1729-4061.2014.20797
19. Yakavets N. V., Krut'ko N. P., Opanasenko O. N. Determination of surface free energy of powdery resin-asphaltene substances by Owens-Wendt-Rabel-Kaelble method // Sviridov readings. 2012. Issue 8. P. 253–260.
20. Kraevye ugly smachivaniya kak indikator struktury poverhnostey polimerov / Bogdanova Yu. G., Dolzhikova V. D., Tsvetkova D. S., Karzov I. M., Alent'ev A. Yu. // Zhurnal strukturnoy himii. 2011. Vol. 52, Issue 6. P. 1224–1231.
21. Badanova A. K., Taussarova B. R., Kutzhanova A. Z. Hydrophobic finishing of cellulosic textile material // World Applied Science Journal. 2014. Vol. 30, Issue 10. P. 1409–1416.
22. Research of the intermolecular interactions and structure in epoxyamine composites with dispersed oxides / Danchenko Yu., Andronov V., Barabash E., Obigenko T., Rybka E., Meleshchenko R., Romin A. // Eastern-European Journal of Enterprise Technologies. 2017. Vol. 6, Issue 12 (90). P. 4–12. doi: 10.15587/1729-4061.2017.118565

23. Research into surface properties of disperse fillers based on plant raw materials / Danchenko Y., Andronov V., Kariev A., Lebedev V., Rybka E., Meleshchenko R., Yavorska D. // *Eastern-European Journal of Enterprise Technologies*. 2017. Vol. 5, Issue 12 (89). P. 20–26. doi: 10.15587/1729-4061.2017.111350
24. Danchenko Yu. M., Kachomanova M. P. Kompleksna otsinka kyslotno-osnovnykh vlastyvostei poverkhni dyspersnykh oksydneykh napovniuvachiv // *Naukovyi visnyk budivnytstva*. 2016. Vol. 86, Issue 4. P. 164–172.
25. Terpilowski K. Influence of the ambient temperature on water and diiodomethane contact angle with quartz surface // *Annales UMCS, Chemia*. 2015. Vol. LXX, Issue 1. P. 125–136. doi: 10.1515/umcschem-2015-0009
26. Zinina I. N., Pimanov M. V. Vliyanie poverhnostnoy energii metallicheskih obraztsov na prochnost' kleevykh soedineniy // *Izvestiya MGTU «MAMI»*. 2011. Issue 2 (12). P. 127–130.
27. Cherkasova N. G., Mokienko R. L., Mihaylova O. I. Issledovanie vliyaniya sostava i rezhima otverzhdeniya na poverhnostnyu energiyu epoksidopolimera // *Voprosy himii i himicheskoy tekhnologii*. 2002. Issue 3. P. 241–244.
28. Park J.-J., Yoon K.-G., Lee J.-Y. Thermal and Mechanical Properties of Epoxy/Micro- and Nano- Mixed Silica Composites for Insulation Materials of Heavy Electric Equipment // *Transactions on Electrical and Electronic Materials*. 2011. Vol. 12, Issue 3. P. 98–101. doi: 10.4313/teem.2011.12.3.98
29. Effect of silica content on thermal stability of fumed silica/epoxy composites / Tarrío-Saavedra J., López-Beceiro J., Naya S., Artiaga R. // *Polymer Degradation and Stability*. 2008. Vol. 93, Issue 12. P. 2133–2137. doi: 10.1016/j.polymdegradstab.2008.08.006
30. Miller C. M. Adhesion and the surface energy components of natural minerals and aggregates // Submitted to the Office of Graduate Studies of Texas A&M University in partial fulfillment of the requirement for the degree of Master of Science. 2010. 218 p.
31. Investigation into acidbasic equilibrium on the surface of oxides with various chemical nature / Danchenko Y., Andronov V., Rybka E., Skliarov S. // *Eastern-European Journal of Enterprise Technologies*. 2017. Vol. 4, Issue 12 (88). P. 17–25. doi: 10.15587/1729-4061.2017.108946
32. Danchenko Yu. M. Strukturirovanie epoksidnoy smoly v prisutstvii neinogennoho poverhnostno-aktivnoho veshchestva // *Budivelni materialy ta vyroby*. 2017. Issue 5-6. P. 26–28.
33. Leonova N. G., Mihal'chuk V. M., Beloshenko V. A. Ustoychivost' k termookislitel'noy destruktzii epoksi-kremnezemnykh kompozitov kationnoy polimerizatsii // *Naukovi pratsi Donetskoho natsionalnoho tekhnichnoho universytetu*. 2011. Issue 17. P. 86–92.
34. Mikroheterohenna struktura kompozytiv na osnovi epoksydnoi smoly ta oksydu Fe(III) abo Al(III) / Shtompel V. I., Demchenko V. L., Vilenskyi V. O., Kercha Yu. Yu. // *Polimernyi zhurnal*. 2008. Vol. 30, Issue 3. P. 233–238.
35. Issledovanie molotogo karbonata kal'tsiya v sostave epoksidnykh kompozitsiy / Talalay A. V., Grigorenko T. I., Burmistr M. V., Kochergin Yu. S. // *Voprosy himii i himicheskoy tekhnologii*. 2007. Issue 1. P. 121–123.
36. Fiziko-himicheskie zakonomernosti sozdaniya novykh gibridnykh epoksidopolimernykh nanokompozitov s povyshennymi prochnostnymi harakteristikami / Sitnikov P. A., Ryabkov Yu. I., Belyh A. G., Vaseneva I. N., Kuchin A. V. // *Izvestiya Komi nauchnogo tsentra UrO RAN*. 2016. Issue 1 (25). P. 18–22.